

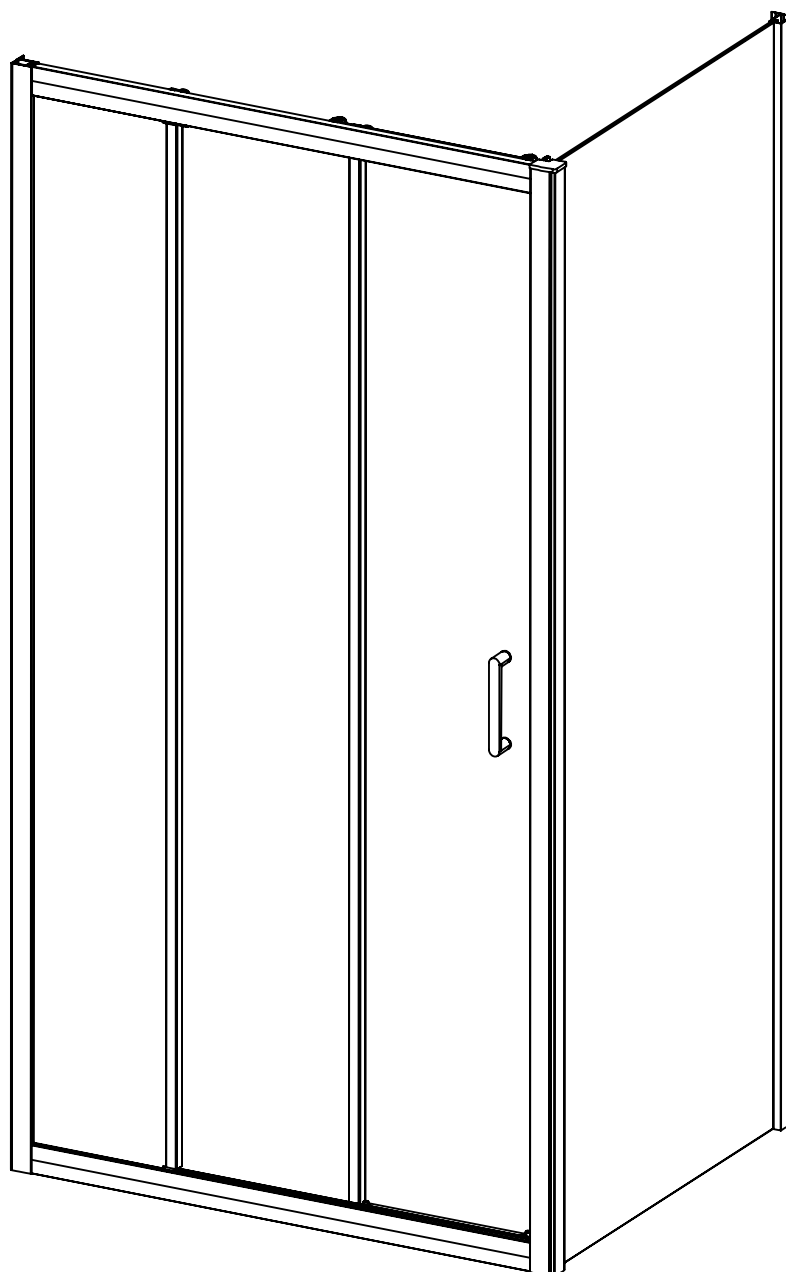

NEW VARIA

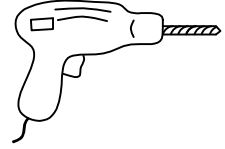

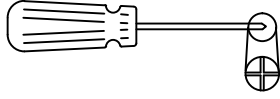
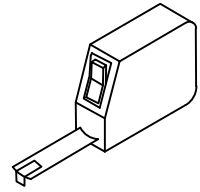
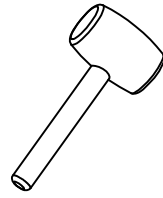
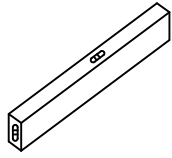

∅2.8 ∅6

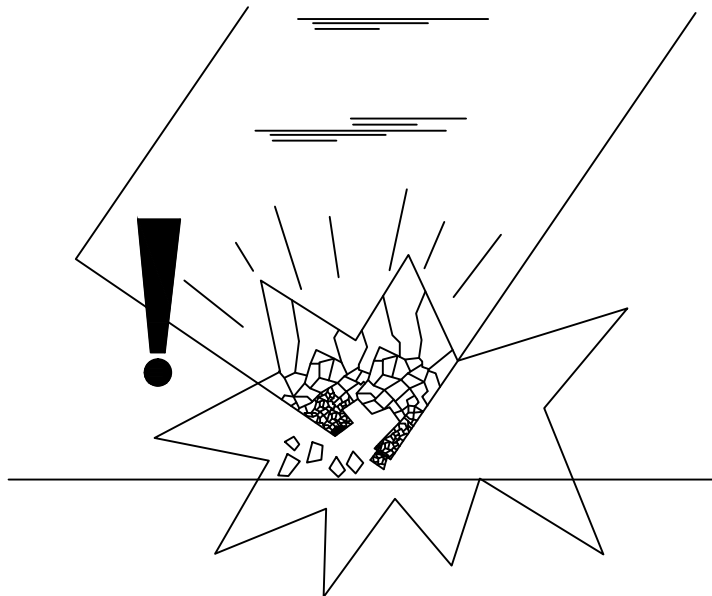
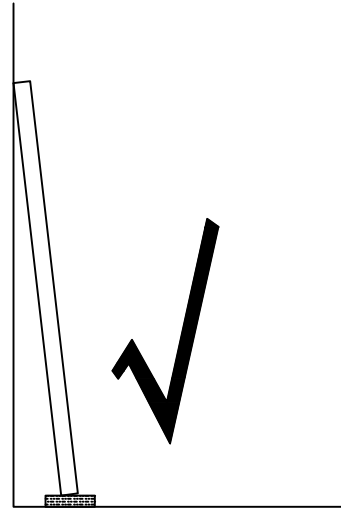
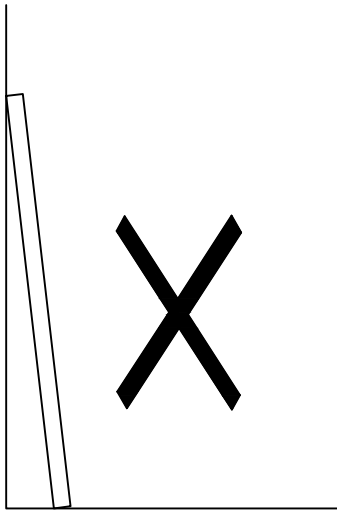
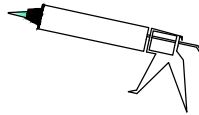

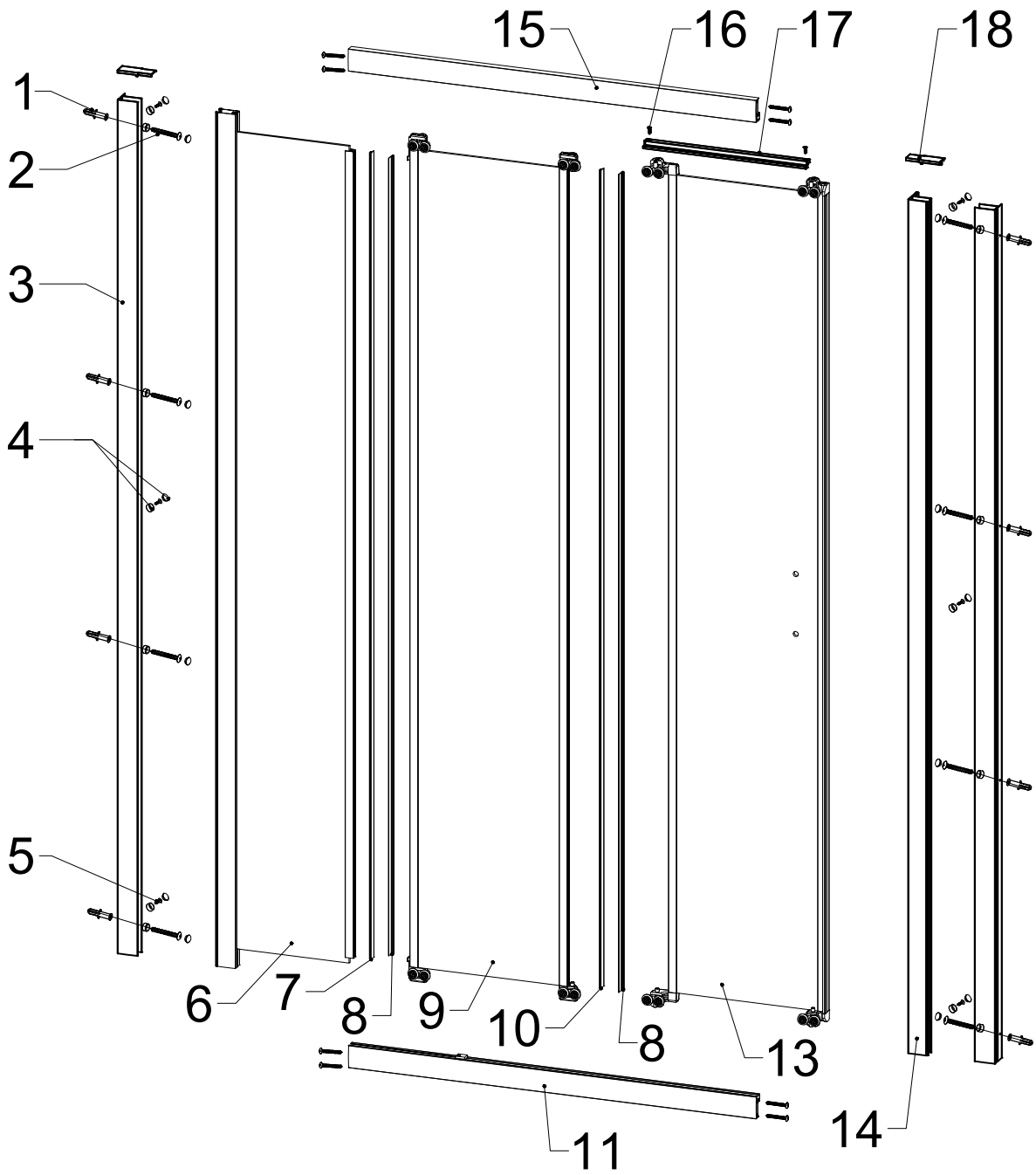

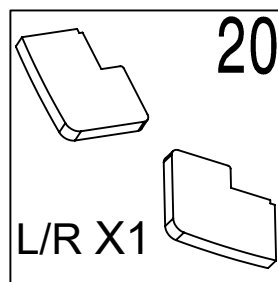
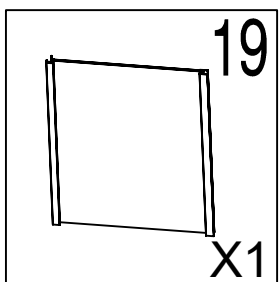
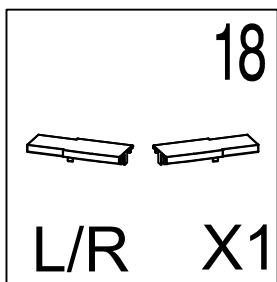
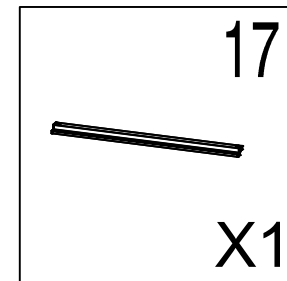
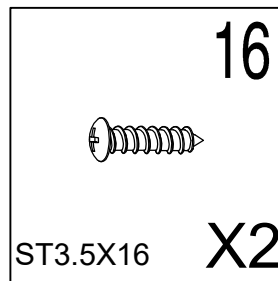
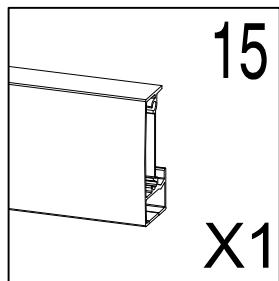
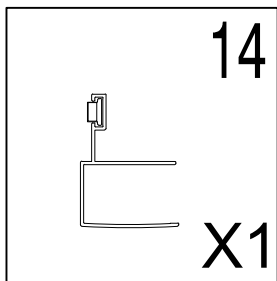
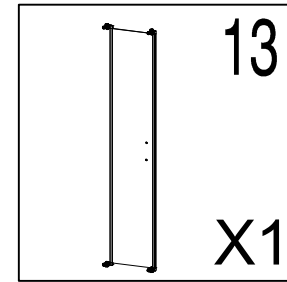
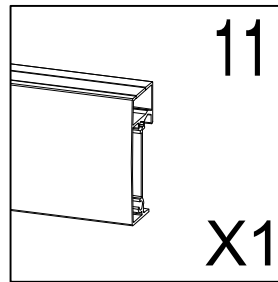
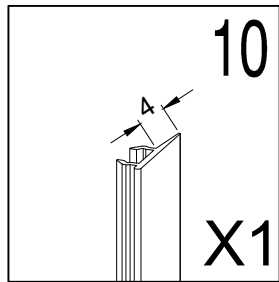
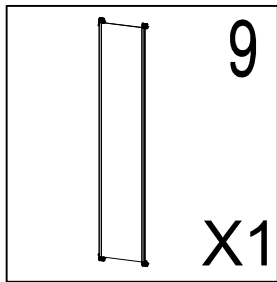
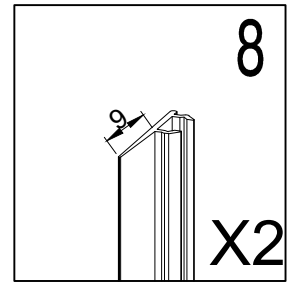
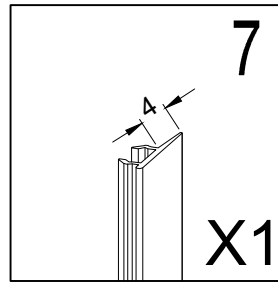
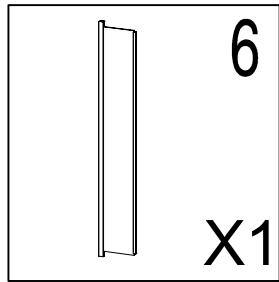
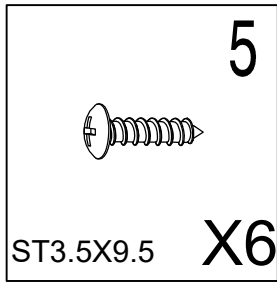
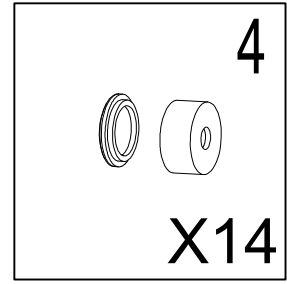
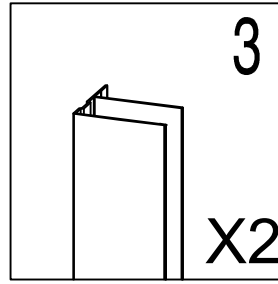
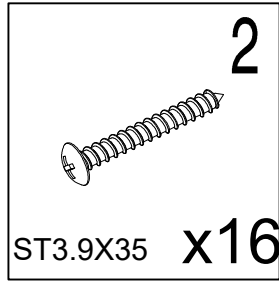
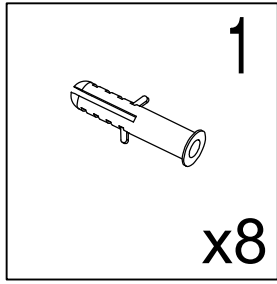

L

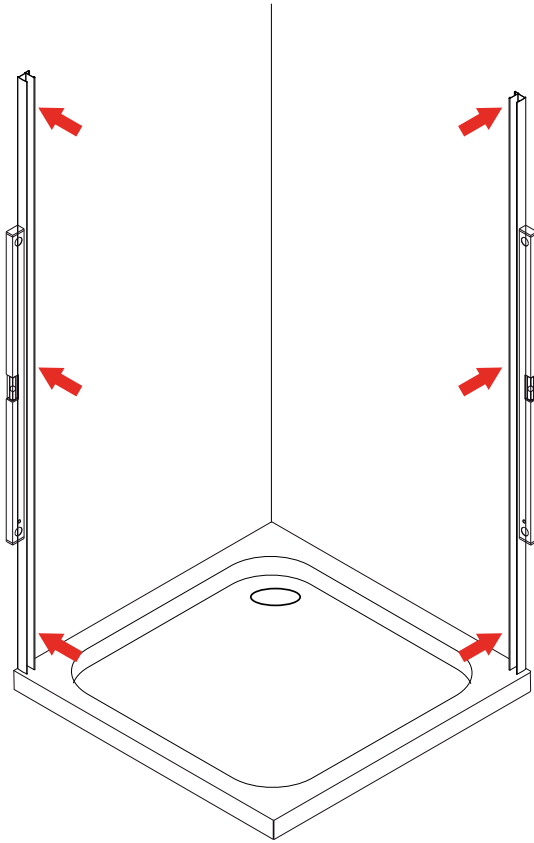
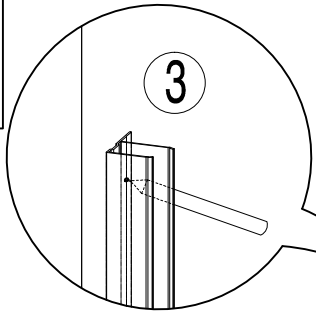

R

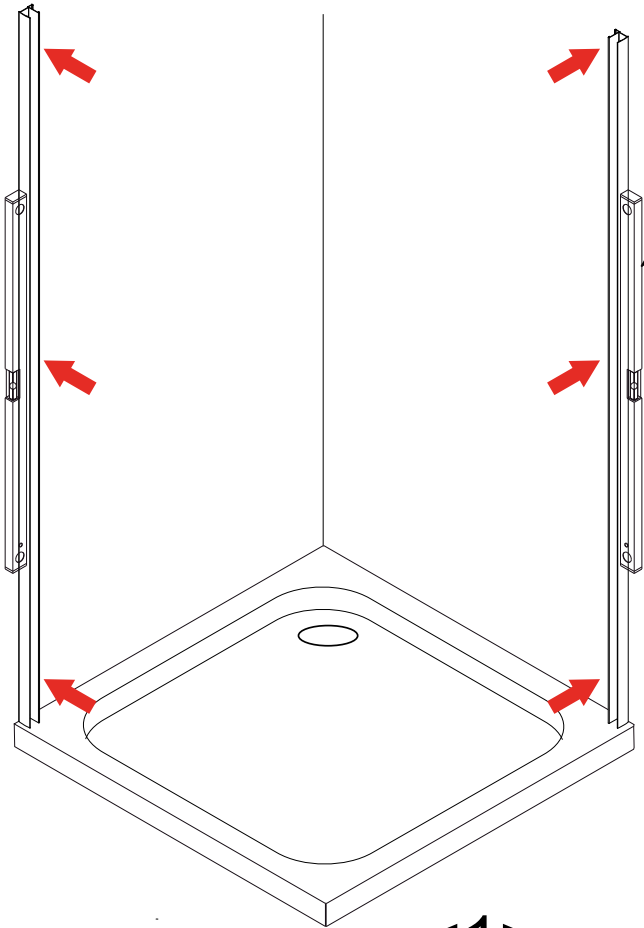
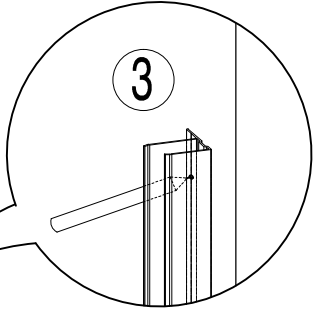

<1>

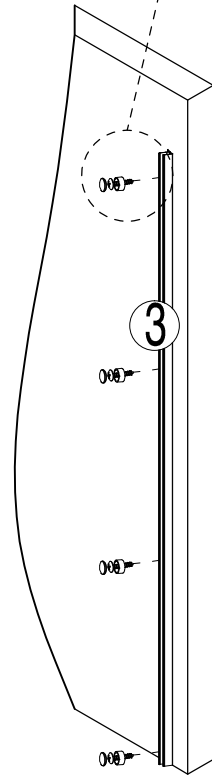
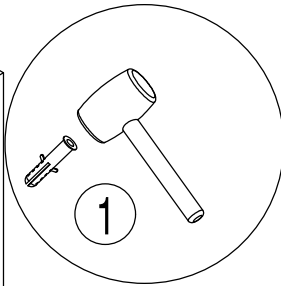
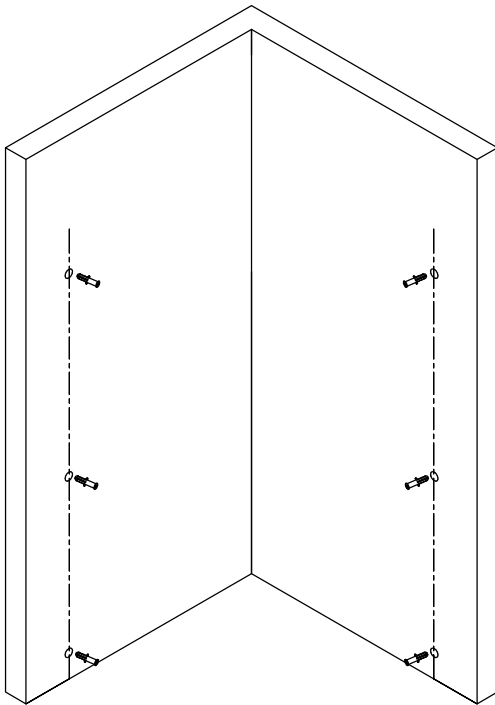
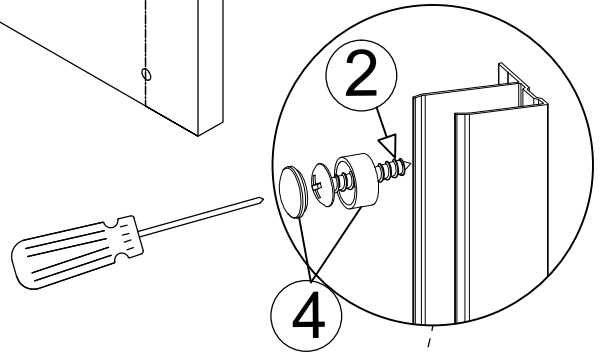
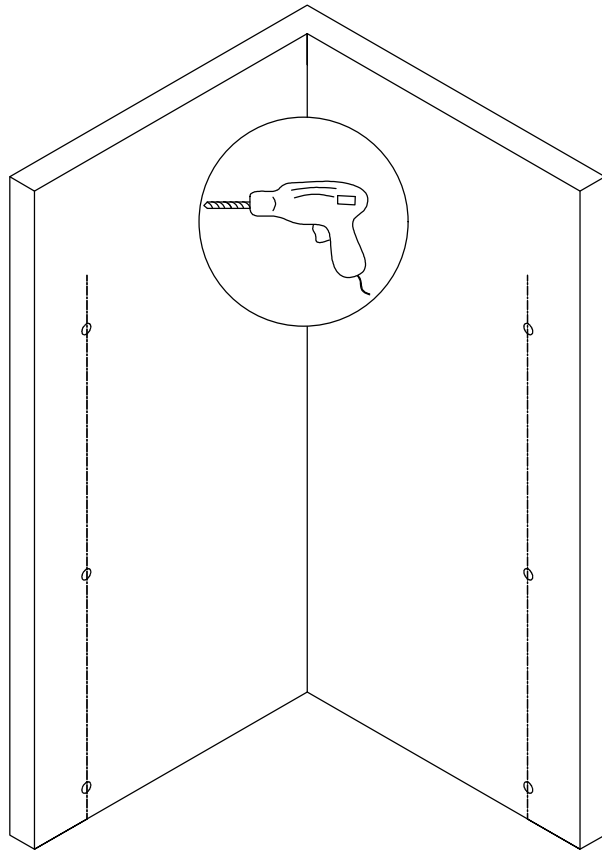
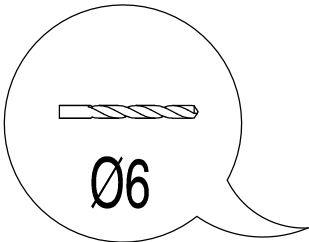

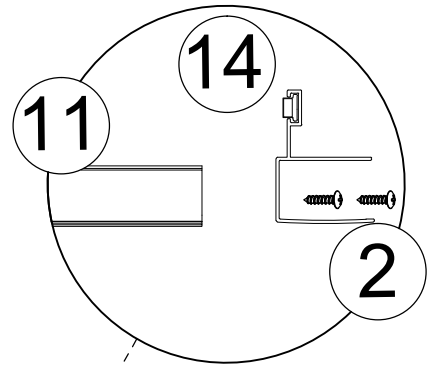
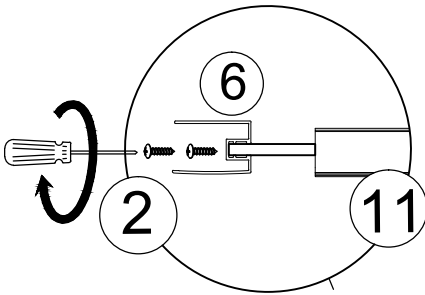
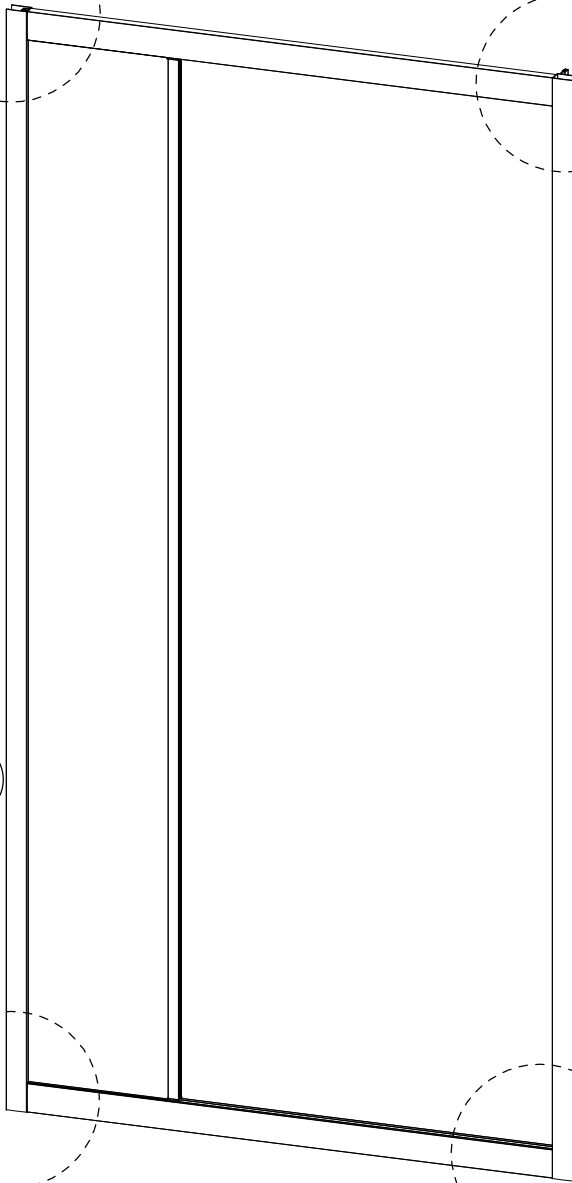
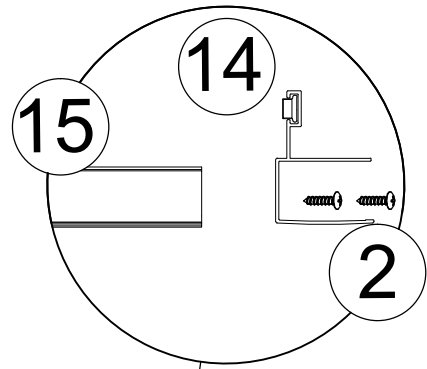
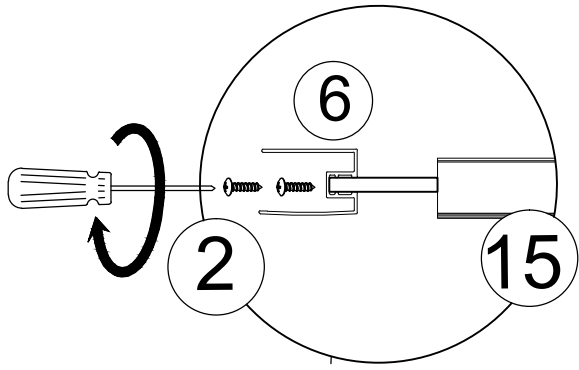
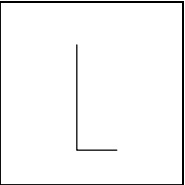

R

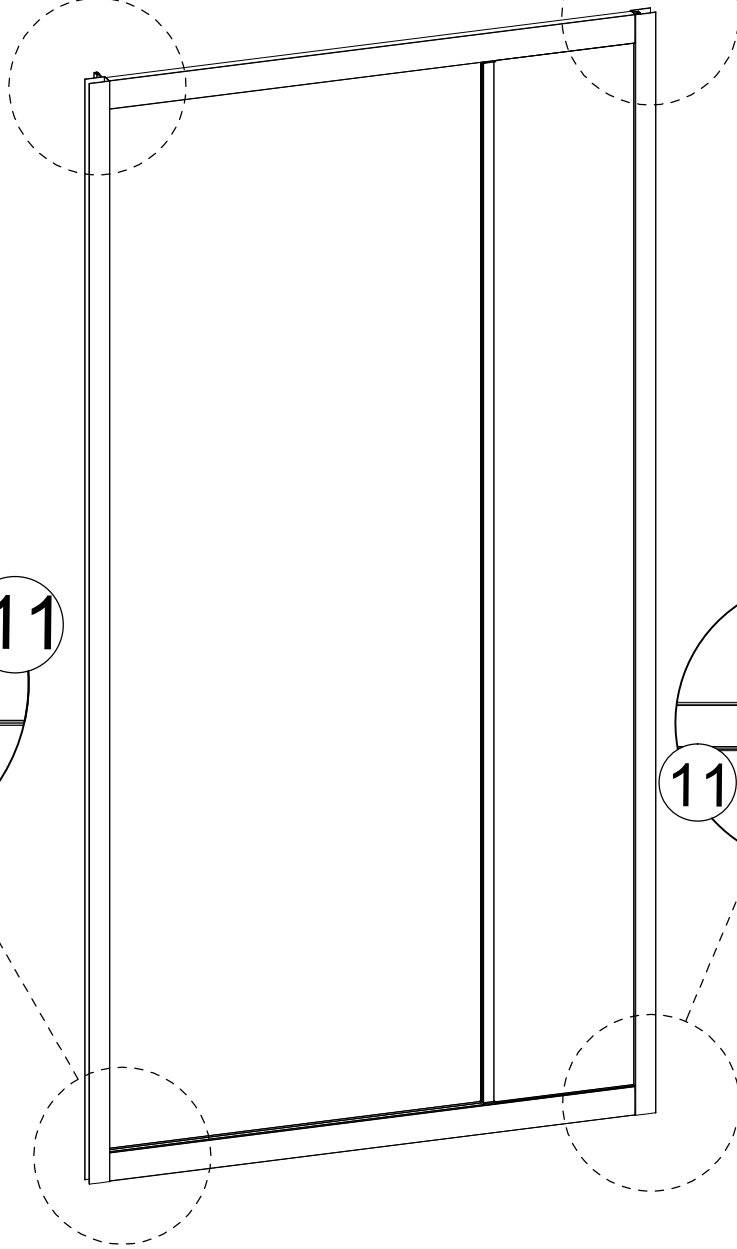
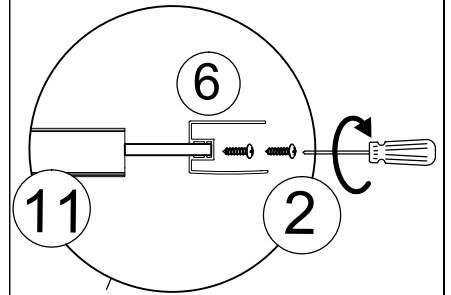
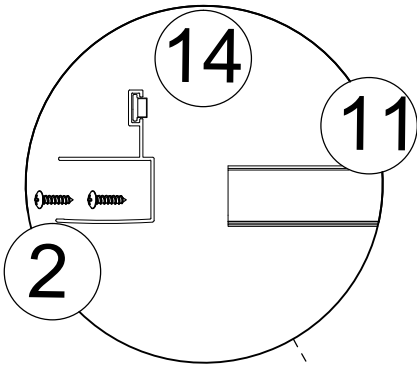
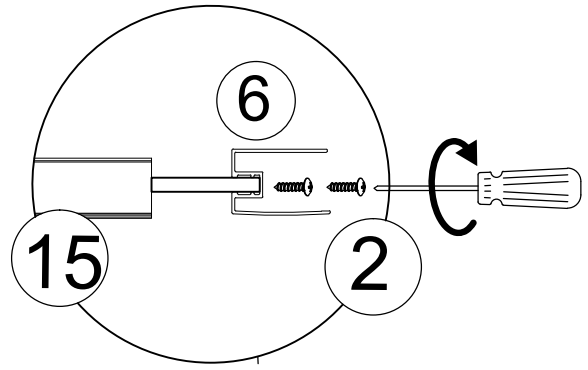
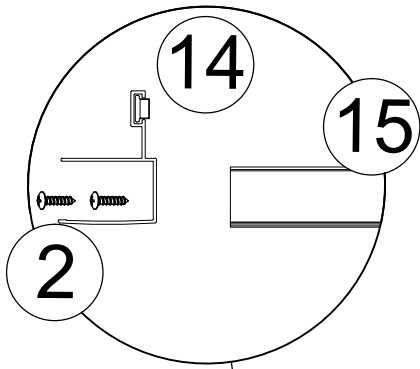

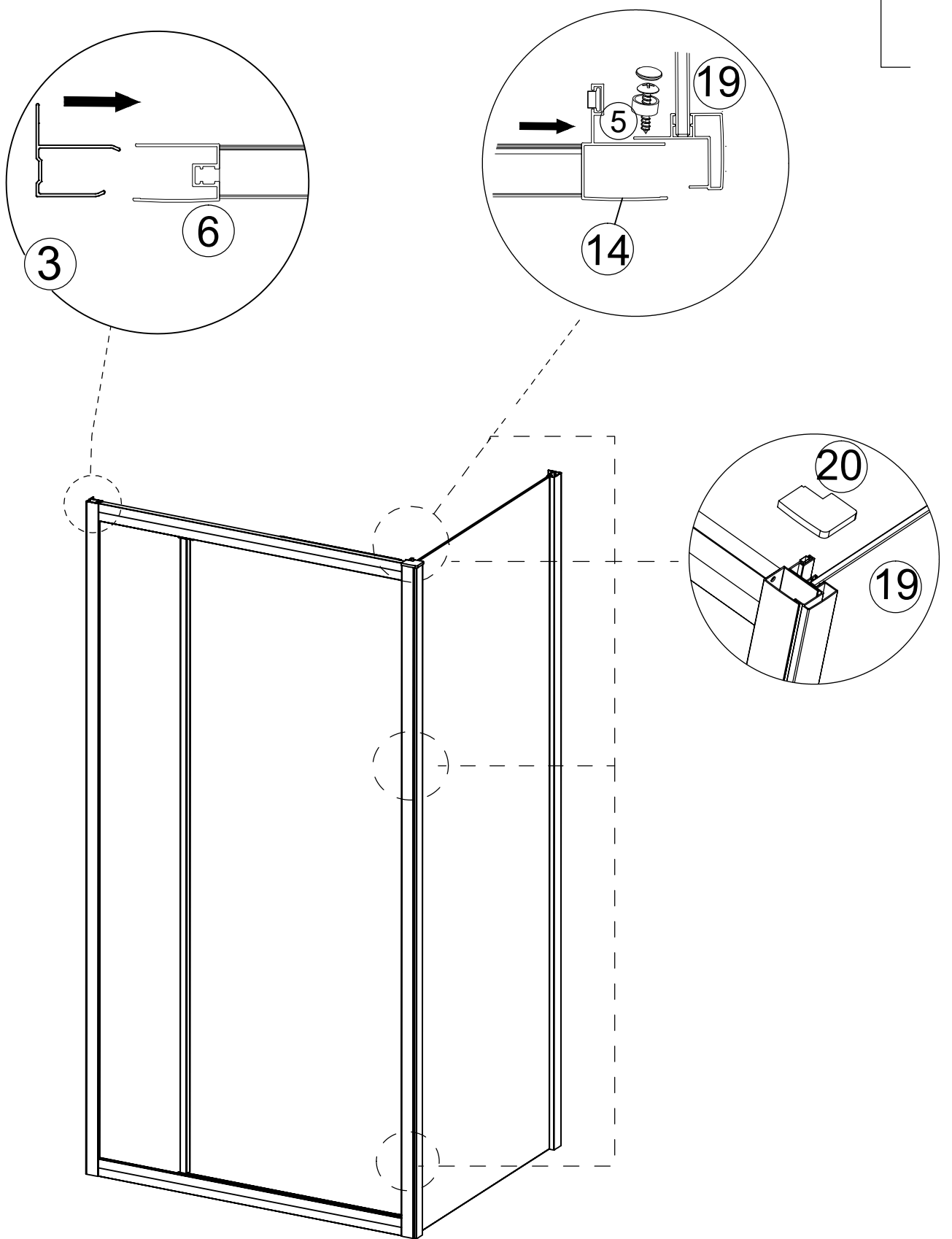

L

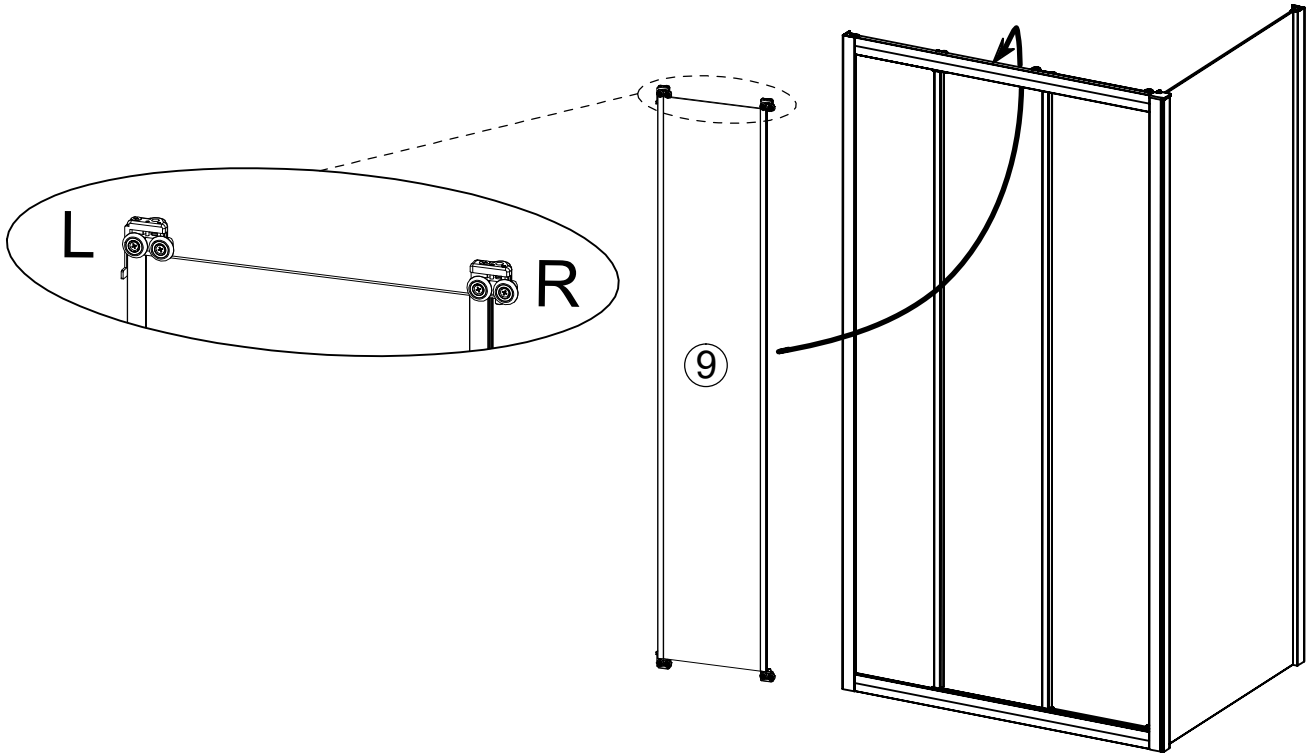

R

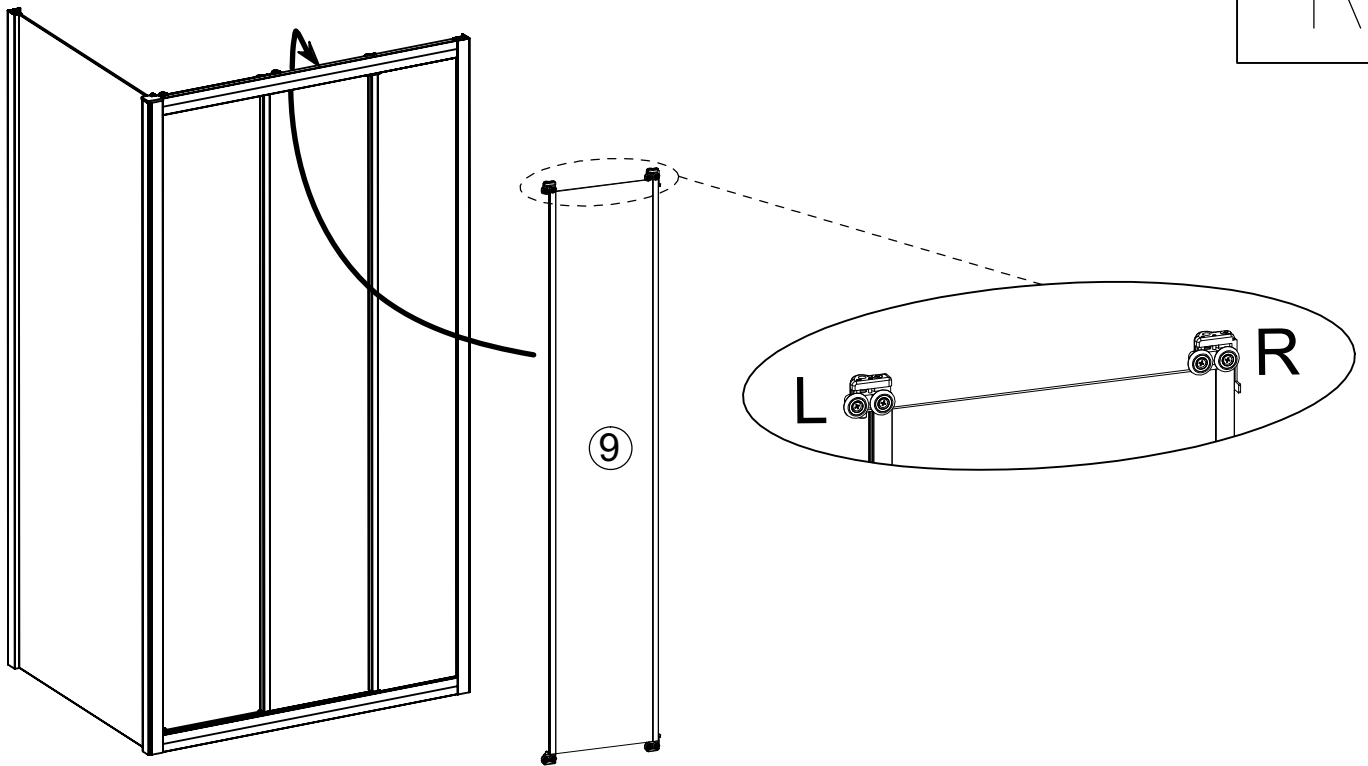

<6>

L

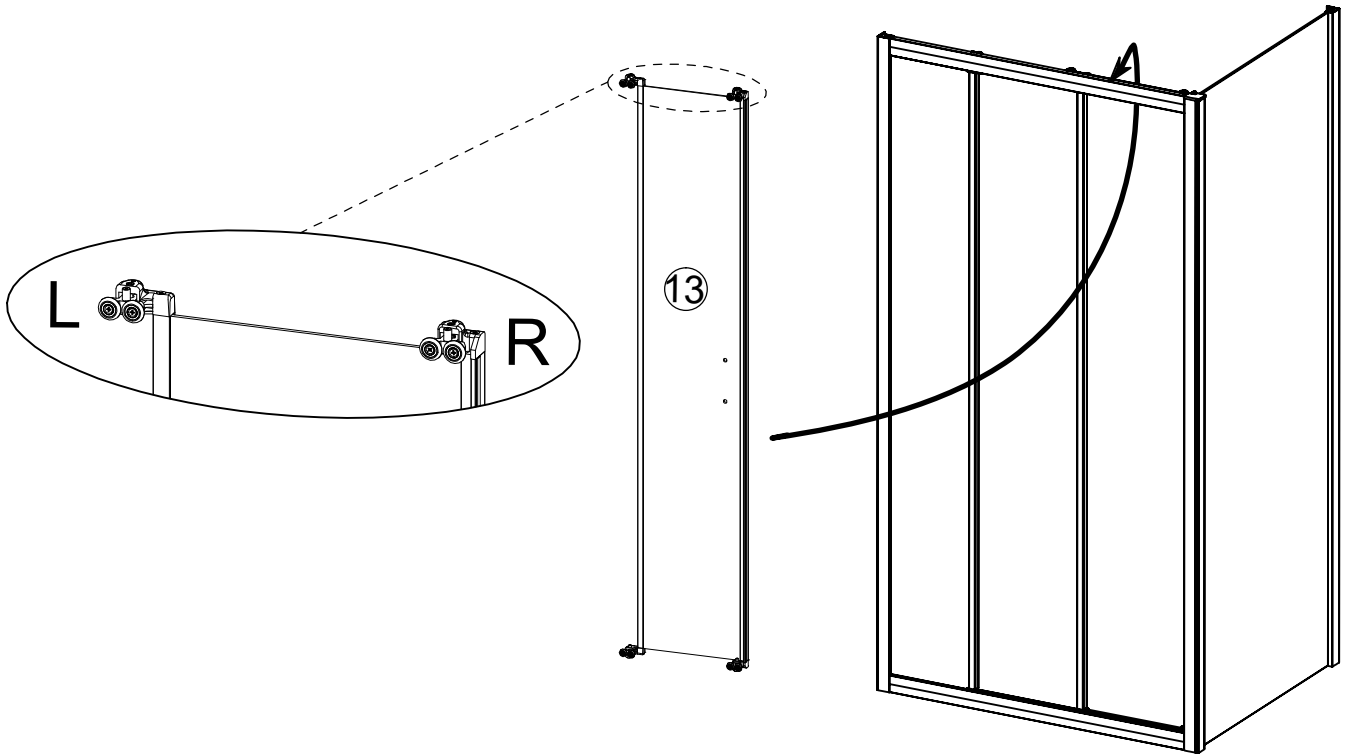

R

